

**Soft Served
 Capri Soft Ice Cream Dispenser, 1
 flavour, electronical control & touch
 panel, 240cones/h-gravity**

ITEM # _____

MODEL # _____

NAME # _____

SIS # _____

AIA # _____

560066 (CAP118DGA3PH)

Soft ice cream dispenser with 13 l tank capacity and 1,95 l cylinder volume, 1 flavour, electronical control and touch screen panel, countertop, hourly production: 240 cones (75 gr), gravity version, R452A

Short Form Specification

Item No. _____

Soft ice cream and frozen yogurt dispenser with 13 l tank capacity and 1,95 l cylinder volume, 1 flavour, hourly production: 240 cones (75gr). Digital control and touch screen panel. It is a countertop appliance with gravity system. Tank agitator and stainless steel drip tray are included as standard. Air-cooled version: requires no water connections that means less operating costs and it is easy to install.

Main Features

- Countertop appliance with gravity system delivers soft ice cream and frozen yogurt, single-flavor equipment.
- Equipped with a 13 liters tank capacity and dispenses up to 240 cones/h (75 gr cones).
- Digital control with touch screen.
- The machine is equipped with tank agitator and stainless steel drip tray.
- The gravity machine is extremely easy to use, clean and maintain. Ice cream has a strong and very intense flavor.

Construction

- Air-cooled version requires no water connections that means low operating costs and easy installation.
- Environmentally friendly: R452a as refrigerant gas.

APPROVAL: _____



Electrolux
PROFESSIONAL

Soft Served
Capri Soft Ice Cream Dispenser, 1 flavour,
electronical control & touch panel, 240cones/
h-gravity

Front

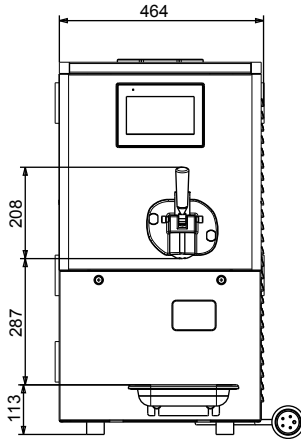

Side

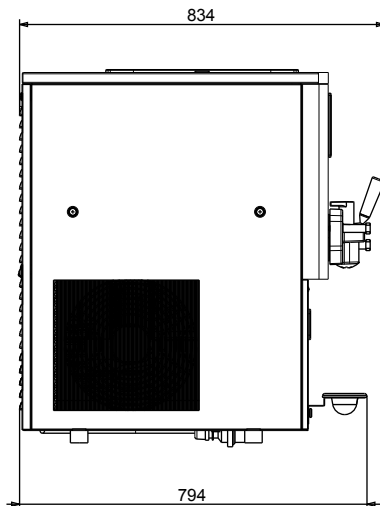

Top

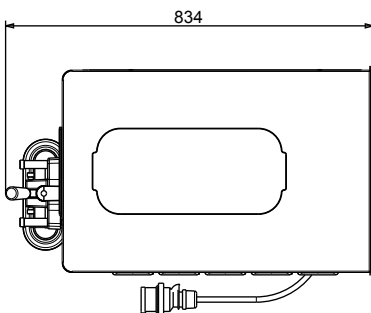

Electric

Supply voltage:

560066 (CAP118DGA3PH) 380-400 V/3N ph/50 Hz

Electrical power max.:

2 kW

Key Information:

External dimensions, Width: 465 mm

External dimensions, Depth: 831 mm

External dimensions, Height: 846 mm

Net weight: 120 kg

Freezing cylinder capacity: 1.95 l

Preparation system: Gravity

N° of hoppers/grinders: 1

Hopper capacity: 13 l

Plug type: IEC/EN 60309-1/2

Refrigeration Data

Operating temperature min.: 20 °C

Operating temperature max.: 36 °C

Sustainability

Refrigerant type: R452A

Refrigerant weight: 780 g



Soft Served
Capri Soft Ice Cream Dispenser, 1 flavour, electronical control & touch
panel, 240cones/h-gravity
The company reserves the right to make modifications to the products
without prior notice. All information correct at time of printing.

2024.09.15